

Series 5V vertical electromechanical axis

Sizes 50, 65, 80

SERIES 5V ELECTROMECHANICAL AXIS



- » High dynamics
- » Easy to integrate in x-y-z systems
- » Strokes up to 1500 mm
- » Version with integrated shock absorbers

The 5V vertical electromechanical axis represents the ideal solution for applications that require vertical displacements as for example pick and place, dispensing, loading/unloading systems (plastic injection moulding, assembly, machining) or palletisers. Available in three sizes, 50, 65 and 80, it can be used as vertical axis of a x,y,z gantry system or cantilever in applications that require to move loads for long strokes quickly and thus optimise the machine cycle time.

The new Series 5V axes are mechanical linear actuators with toothed belt. Thanks to a specific pulley system with omega configuration, these axes allow to reduce to a minimum the inertia of the system. Furthermore, the presence of one or more recirculating ball guides (HS version) as well as of a special self-supporting square profile provides high stiffness and resistance to dynamic loads, ensuring a precise and fast displacement of heavy loads.

GENERAL DATA

Construction	electromechanical axis with toothed belt
Design	open profile with protection plate
Operation	linear multi-position actuator
Sizes	50, 65, 80
Strokes	max 1500 mm
Type of guide	internal, with recirculating balls (cage type)
Fixing	by means of dedicated accessories
Mounting motor	on both sides
Operating temperature	-10°C ÷ +50°C
Storage temperature	-20°C ÷ +80°C
Protection class	IP 20
Lubrication	centralized lubrication by means of internal channels
Repeatability	± 0.05 mm
Duty cycle	100%
Use with external sensors	C5H and CST magnetic switches by means of accessories Mod. SMS

CODING EXAMPLE

5V	S	050	TBL	0200	A	S	1
5V	SERIES						
S	PROFILE: S = square section						
050	FRAME SIZE: 050 = 50x50 mm 065 = 65x65 mm 080 = 80x80 mm						
TBL	TRANSMISSION: TBL = toothed belt						
0200	STROKE [C]: 0050 ÷ 1500 mm						
A	VERSION: A = standard						
S	TYPE OF SLIDER: S = standard						
1	NUMBER OF SLIDERS: 1 = 1 slider						
	TYPE OF END CAP: = standard SA = shock absorber integrated						

MECHANICAL CHARACTERISTICS

(A) Value refers to a covered distance of 2000 Km with fully supported system.

	Measuring unit	Size 50	Size 65	Size 80
RECIRCULATING BALL GUIDE (CAGE TYPE)				
Version		A	A	A
Type of slider		S	S	S
Number of RDS blocks	pcs	2	2	2
Dynamic load of RDS blocks (C)	N	11640	28400	44600
Max admissible load (Cmax z, Cmax y)	N	3100(A)	8300(A)	13100(A)
Max admissible moment (Mmax x)	Nm	22.44	96.00	216.60
Max admissible moment (Mmax y, Mmax z)	Nm	45.30	269.40	525.00
Max linear speed of mechanics (Vmax)	m/s	3	3	3
Max linear acceleration of mechanics (amax)	m/s ²	30	30	30
PROFILE				
Moment of surface inertia Iy	mm ⁴	1.89 · 10 ⁵	4.94 · 10 ⁵	1.23 · 10 ⁶
Moment of surface inertia Iz	mm ⁴	2.48 · 10 ⁵	6.97 · 10 ⁵	1.68 · 10 ⁶
TOOTHED BELT				
Type		25 AT 5 HP	40 AT 5 HP	45 AT 10 HP
Pitch	mm	5	5	10
Safe loads	N	See the diagram	See the diagram	See the diagram
PULLEY				
Effective diameter of the pulley	mm	47.75	57.30	76.39
Number of teeth	z	30	36	24
Linear movement per pulley round	mm/round	150	180	240

SERIES 5V MATERIALS

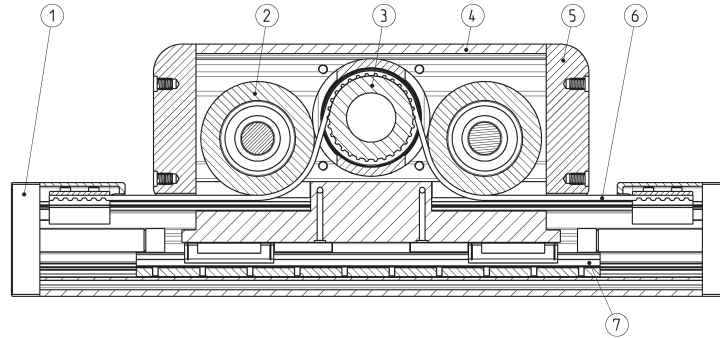

COMPONENTS	MATERIALS
1. End cap	Aluminium alloy
2. Idler	Aluminium alloy
3. Pulley	Steel
4. Omega body	Aluminium alloy
5. Cover	Aluminium alloy
7. Belt	PU + Steel
8. Recirculating ball guide	Steel

HOW TO CALCULATE THE LIFE OF THE AXIS 5V

The correct dimensioning of the axis 5V, used individually or in a cartesian system with several axes, you need to consider some facts, both static and dynamic. Among these, the most important are described on the following pages.

CALCULATION OF LIFE [km]

$$L_{eq} = \left(\frac{C_{ma}}{C_{eq} \cdot f_w} \right)^3 \cdot 2000$$

- Leq = Life of the axis [km]
- Cma = Maximum admissible load [N]
- Ceq = Equivalent load [N]
- fw = safety coefficient according to the working conditions

CALCULATION OF EQUIVALENT LOAD

$$C_{eq} = |F_y| + |F_z| + C_{ma} \cdot \left| \frac{M_x}{M_{x,ma}} \right| + C_{ma} \cdot \left| \frac{M_y}{M_{y,ma}} \right| + C_{ma} \cdot \left| \frac{M_z}{M_{z,ma}} \right|$$

When compression/traction and side loads as well as bending or torque moments act on the system, you need to calculate the equivalent load acting on the system.

- Ceq = Equivalent load [N]
- Fy = Force acting along the Y-axis [N]
- Fz = Force acting along the Z-axis [N]
- Cma = Max admissible load [N]
- Mx = Moment along X-axis [Nm]
- My = Moment along Y-axis [Nm]
- Mz = Moment along Z-axis [Nm]
- M(x,ma) = Max admissible moment along X-axis [Nm]
- M(y,ma) = Max admissible moment along Y-axis [Nm]
- M(z,ma) = Max admissible moment along Z-axis [Nm]

HOW TO CALCULATE THE DRIVING TORQUE [Nm]

F_A = Total force acting from outside [N]
 F_E = Force to be applied externally [N]
 g = Gravitational acceleration [9.81 m/s²]
 m_E = Mass of the body to move [kg]
 D_P = Pulley pitch diameter [mm]
 C_{M1} = Driving torque due to external agents [Nm]

J_{TOT} = Moment of inertia of rotating components [kg·m²]
 ω = Angular acceleration [rad/s²]
 a = Axis linear acceleration [m/s²]
 C_{M2} = Driving torque due to rotating components [Nm]

F_{TT} = Force needed to move translating components [N]
 F_{TF} = Force needed to move fixed-length translating components [N]
 F_{TV} = Force needed to move variable-length translating components [N]
 m_{C1} = Mass of fixed-length translating components [kg]
 K_{TV} = Mass coefficient of variable-length translating components [kg/mm]
 C_{M3} = Driving torque due to translating components [Nm]

According to the axis size and to the speeds chosen, force that can be transmitted from the toothed belt has these limits.

$$C_{TOT} = C_{M1} + C_{M2} + C_{M3}$$

$$F_A = F_E + m_E \cdot (a \pm g)$$

$$C_{M1} = \frac{F_A \cdot D_P}{2}$$

$$\dot{\omega} = \frac{2 \cdot a}{D_P}$$

$$C_{M2} = J_{TOT} \cdot \dot{\omega}$$

$$F_{TT} = F_{TF} + F_{TV}$$

$$F_{TF} = m_{C1} \cdot (a \pm g)$$

$$F_{TV} = K_{TV} \cdot C \cdot (a \pm g)$$

$$C_{M3} = \frac{F_{TT} \cdot D_P}{2}$$

TRANSMISSIBLE FORCE

The force that can be transmitted from the toothed belt depends on the axis size and speeds chosen.

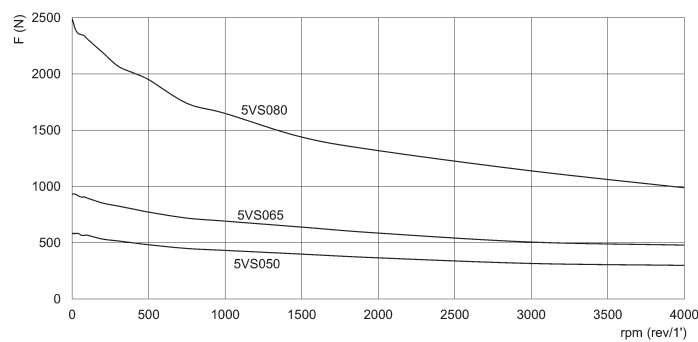

WEIGHT DISTINCTION

- 1 = fixed mass M_f
- 2 = moving mass with stroke zero m_{c1}
- 3 = moving mass that varies according to the stroke K_{tv}

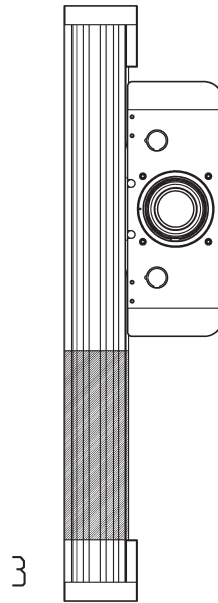
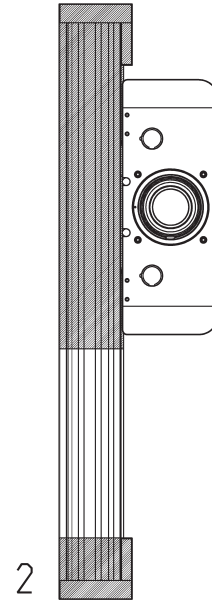
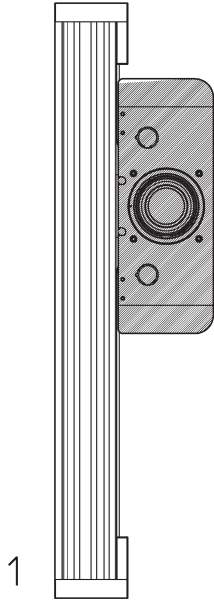

Size	m_{c1} [Kg]	K_{tv} [Kg/m]	M_f [Kg]	tot weight stroke 0 [Kg]
50	1.49	3.15	3.37	4.86
65	2.67	5.13	6.14	8.81
80	6.43	8.3	12.16	18.59

LIFE OF THE SERIES 5V AXIS ACCORDING TO THE EQUIVALENT LOAD

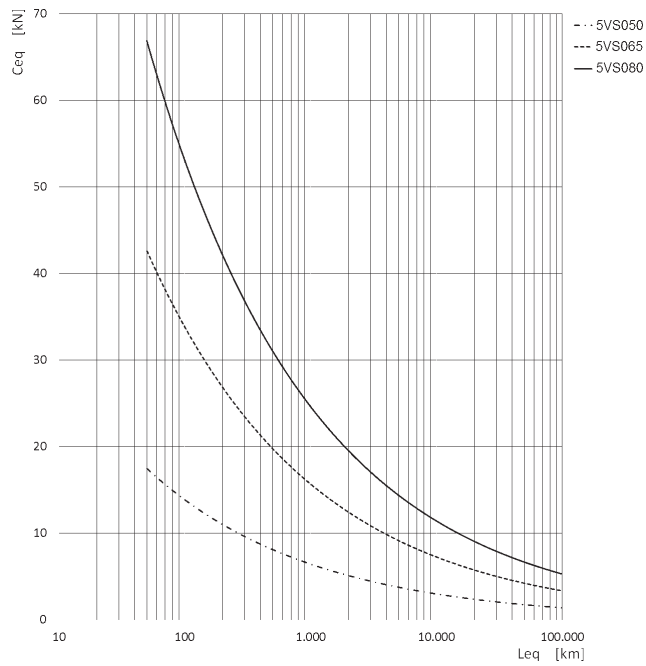

Curves calculated with $f_w = 1$

C_{eq} = Equivalent load applied on the axis [kN]

L_{eq} = Life of the axis [km]

EQUIVALENT LOAD

To determine the moment acting on the axis x, M_x , in an accurate way, refer to the following formula:

$$M_x = F_y \cdot (K + K1)$$

where:

M_x = Moment along X-axis [Nm]

F_y = Force acting along the Y-axis [N]

K = fixed distance for axis 5E [mm]

$K1$ = application arm [mm]

NOTE: here below, the "K" values for the three sizes

- $K = 21$ mm (5VS050)

- $K = 28$ mm (5VS065)

- $K = 36$ mm (5VS080)

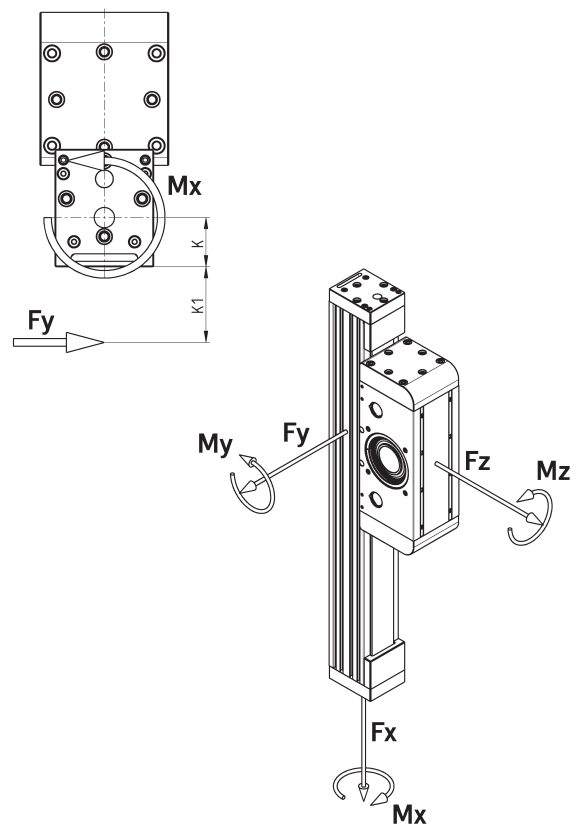

DEFLECTION 5VS050

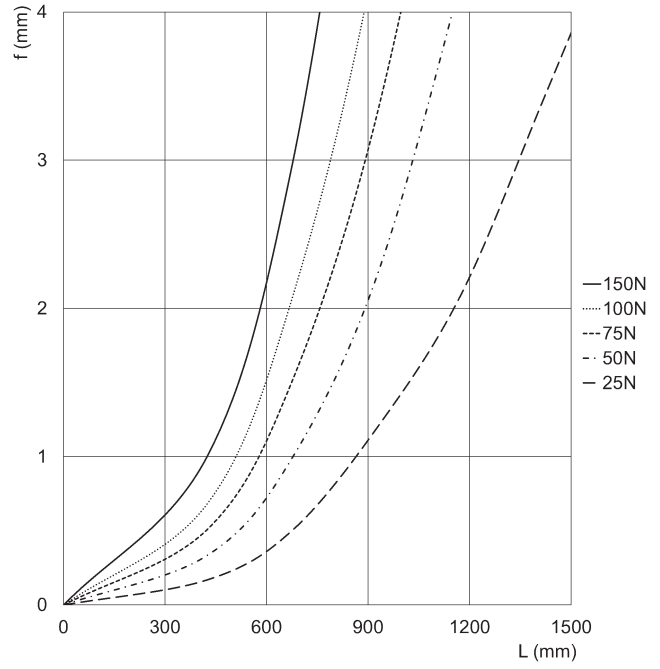
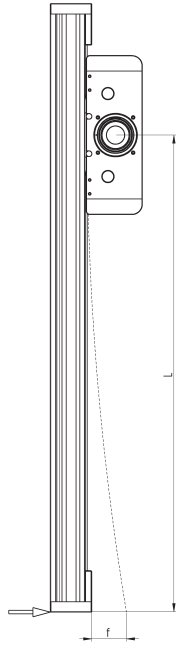

f = generated deflection [mm]
L = arm length [mm]

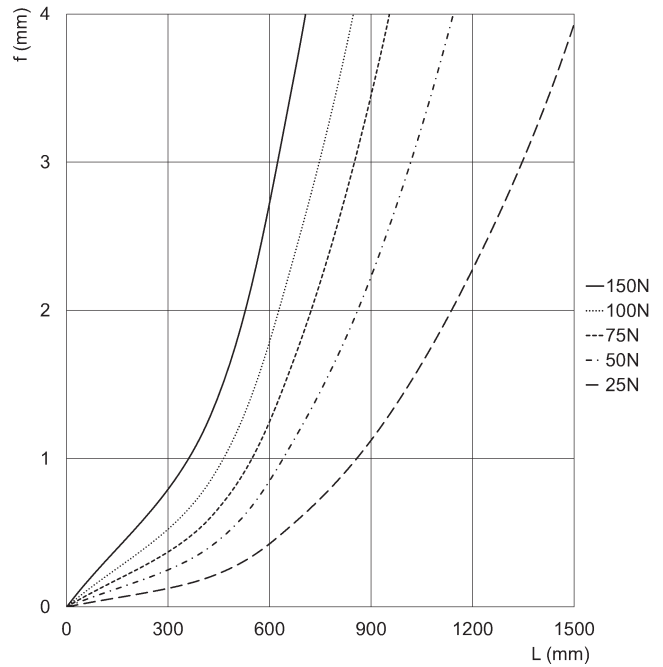
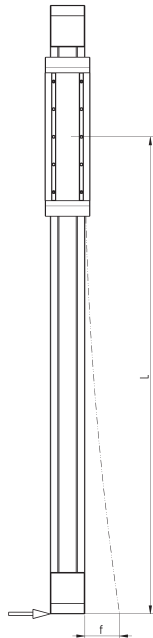

f = generated deflection [mm]
L = arm length [mm]

DEFLECTION 5VS065

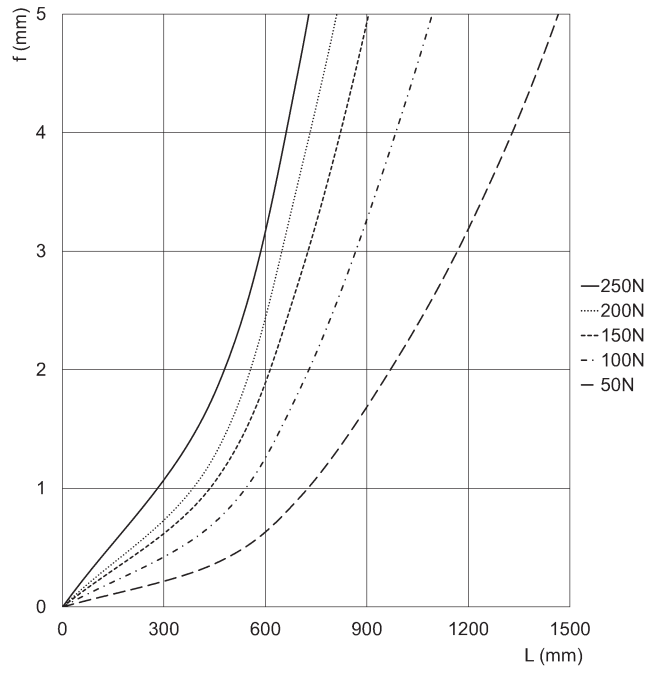
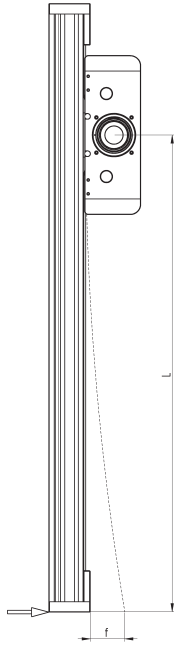

f = generated deflection [mm]
L = arm length [mm]

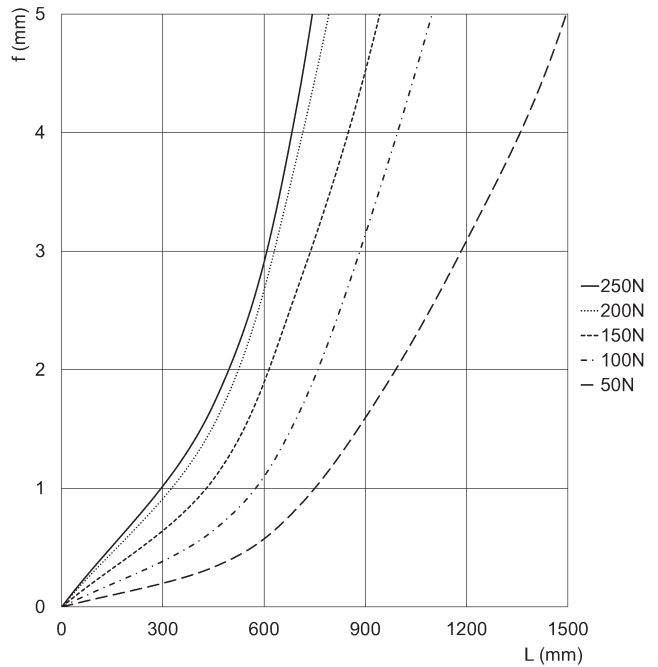
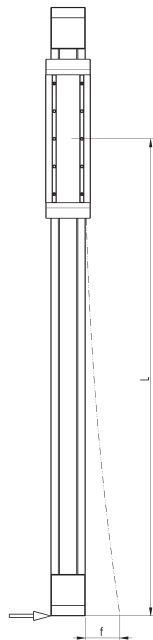

f = generated deflection [mm]
L = arm length [mm]

DEFLECTION 5VS080

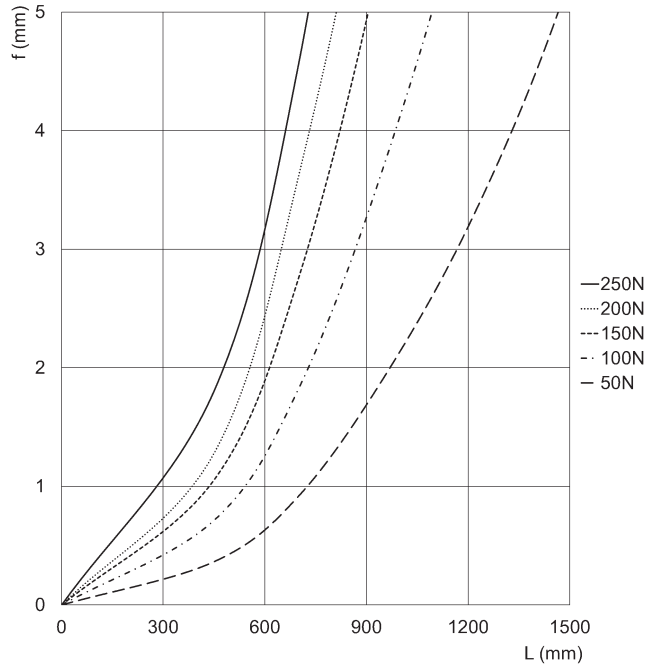
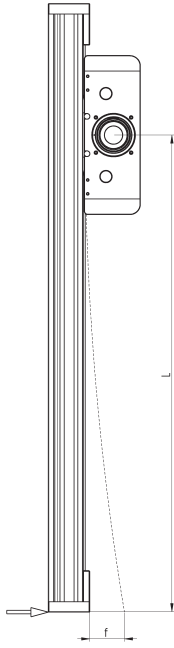

f = generated deflection [mm]
L = arm length [mm]

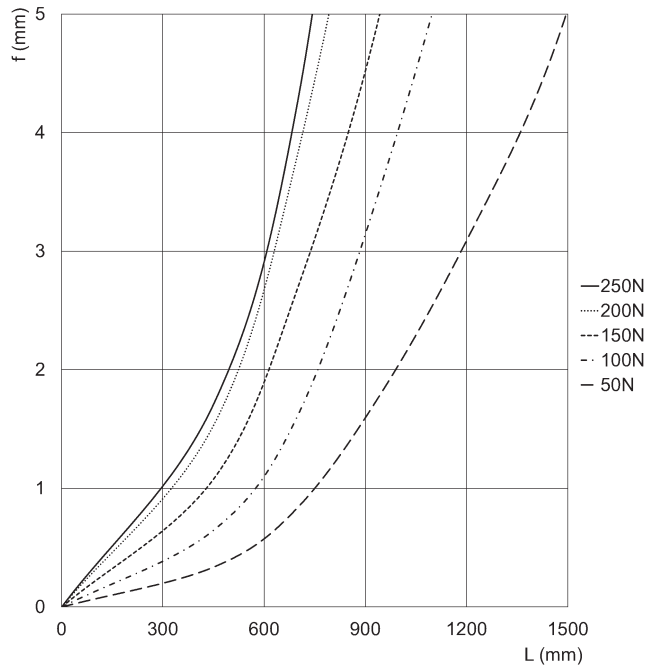
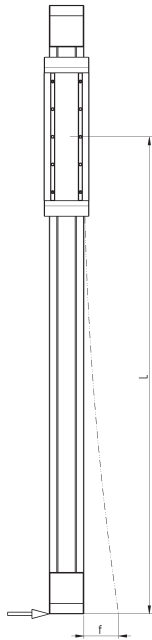

f = generated deflection [mm]
L = arm length [mm]

ACCESSORIES FOR SERIES 5V

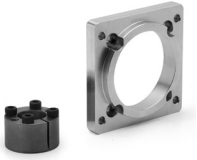

Kit to connect the gearbox

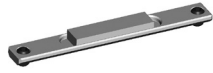

Magnet kit
Mod. SMS-5V-U

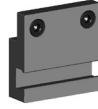

Sensor holder kit
Mod. SMS-5V



Centering ring
Mod. TR-CG



5E/5V connection flange



All accessories are supplied separately from the axis.
Together with the axis, a kit is supplied containing:

- covers to close the holes on the endcap
- centering bushings for the slider
- nipples for greasing

Electromechanical axis Mod. 5V...AS1



+ = add the stroke

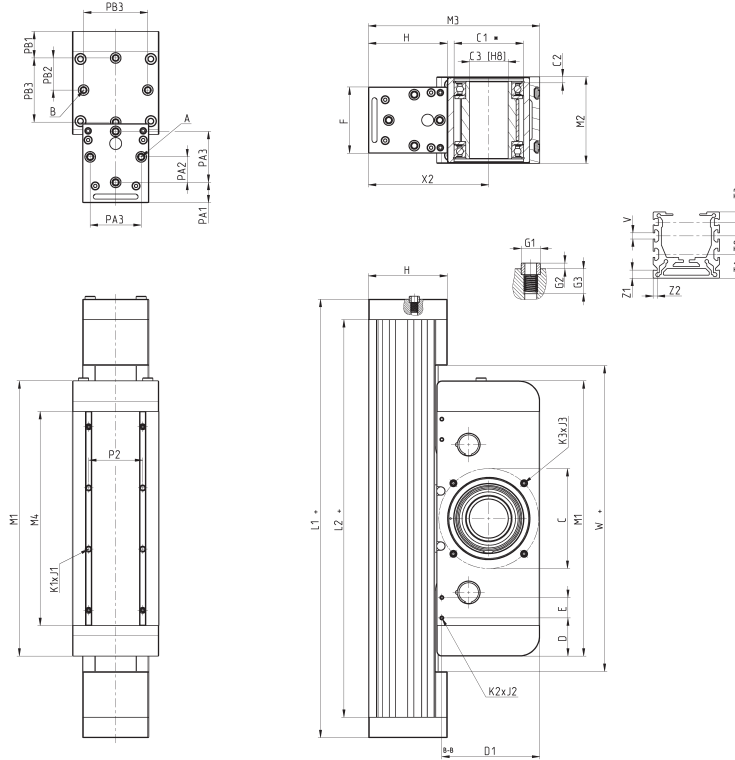

Size	A	B	C	C1	C2	C3(H8)	D	E	F	H	L1	L2	M1	M2	M3	M4	P1	PA1	PA2	PA3	PB1	PB2	PB3	X2	W+	K1xJ1	K2xJ2	K3xJ3	Z1	Z2	V	T1	T2	T3	G1(H8)	G2	G3
50	M5x7.5	M5x7.5	72	52	4.5	26	30	20	50	60	380	350	230	65	133	185	40	14.5	20	40	21	25	50	94.3	260	M4x4.7	M3x6	M5x7.5	8	4	6	20	-	10	8	3	9.5
65	M6x9	M6x9	98	68	4.5	38	37.5	20	65	77.5	430	390	270	85	168	210	60	20	25	50	26	31.5	63	118	300	M5x4.7	M3x6	M6x10	8	4	6	23.5	18	10	10	3	12
80	M8x12	M8x12	133	80	5	47	37.5	20	80	97.5	635	585	365	100	205	305	60	24	32.5	65	37	35	70	144	395	M6x5	M3x6	M8x18	8	4	8	25	25	10	12	3	15

Size	WEIGHT STROKE ZERO [kg]	STROKE WEIGHT PER METER [kg/m]
50	4.86	3.15
65	8.81	5.13
80	18.59	8.3

Kit to connect the gearbox

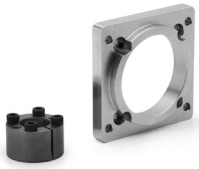

The kit includes:
 1x connection flange
 4x screws + 4x lock washers
 to connect the flange
 1x locking set
 4x screws + 4x lock washers
 to connect the gearbox

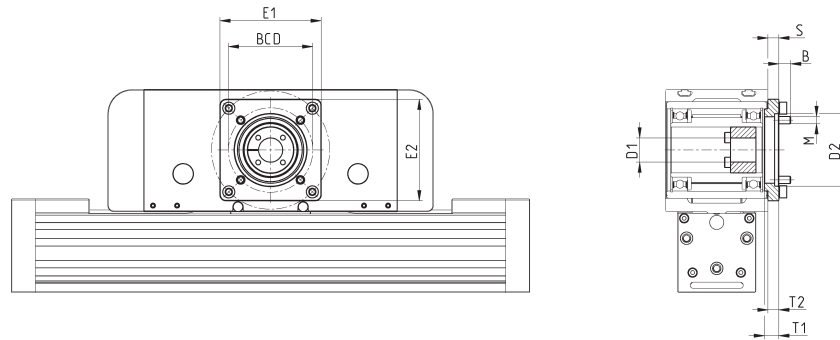

Mod.	Size	Gearbox	E1	E2	S	BCD	$\varnothing D1$	$\varnothing D2^{(M7)}$	T1	T2	M	B	Weight (g)
FR-5V-50	50	GB-060	65	65	6	52	14	40	10	-	5	7.9	130
FR-5V-65	65	GB-080	84	84	9	70	20	60	12	3.5	6	9.8	300
FR-5V-80	80	GB-120	115	115	13	100	25	80	18	4.5	10	15.8	620

Magnet kit Mod. SMS-5V-U

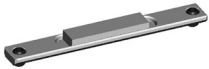

Supplied with:
 1x plate
 1x magnet
 2x locking screws

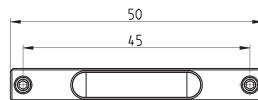

Mod.
 SMS-5V-U

Sensor holder kit Mod. SMS-5V

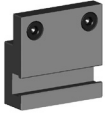

Supplied with:
1x plate
2x screws

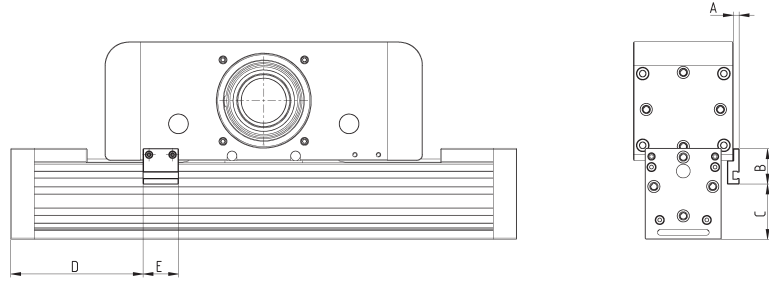

Mod.	Size	A	B	C	D	E
SMS-5V-50	50	7.5	30	32	100	30
SMS-5V-65/80	65	5	30	47	112.5	30
SMS-5V-65/80	80	5	30	63	167.5	30

Centering ring Mod. TR-CG

Supplied with:
2x centering rings in steel

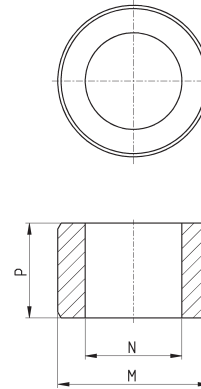

Mod.	M (h8)	N	P
TR-CG-04	Ø4	Ø2.6	2.5
TR-CG-05	Ø5	Ø3.1	3
TR-CG-06	Ø6	Ø4.1	4
TR-CG-08	Ø8	Ø5.1	5
TR-CG-10	Ø10	Ø6.1	6
TR-CG-12	Ø12	Ø8.1	6

5E/5V connection flange

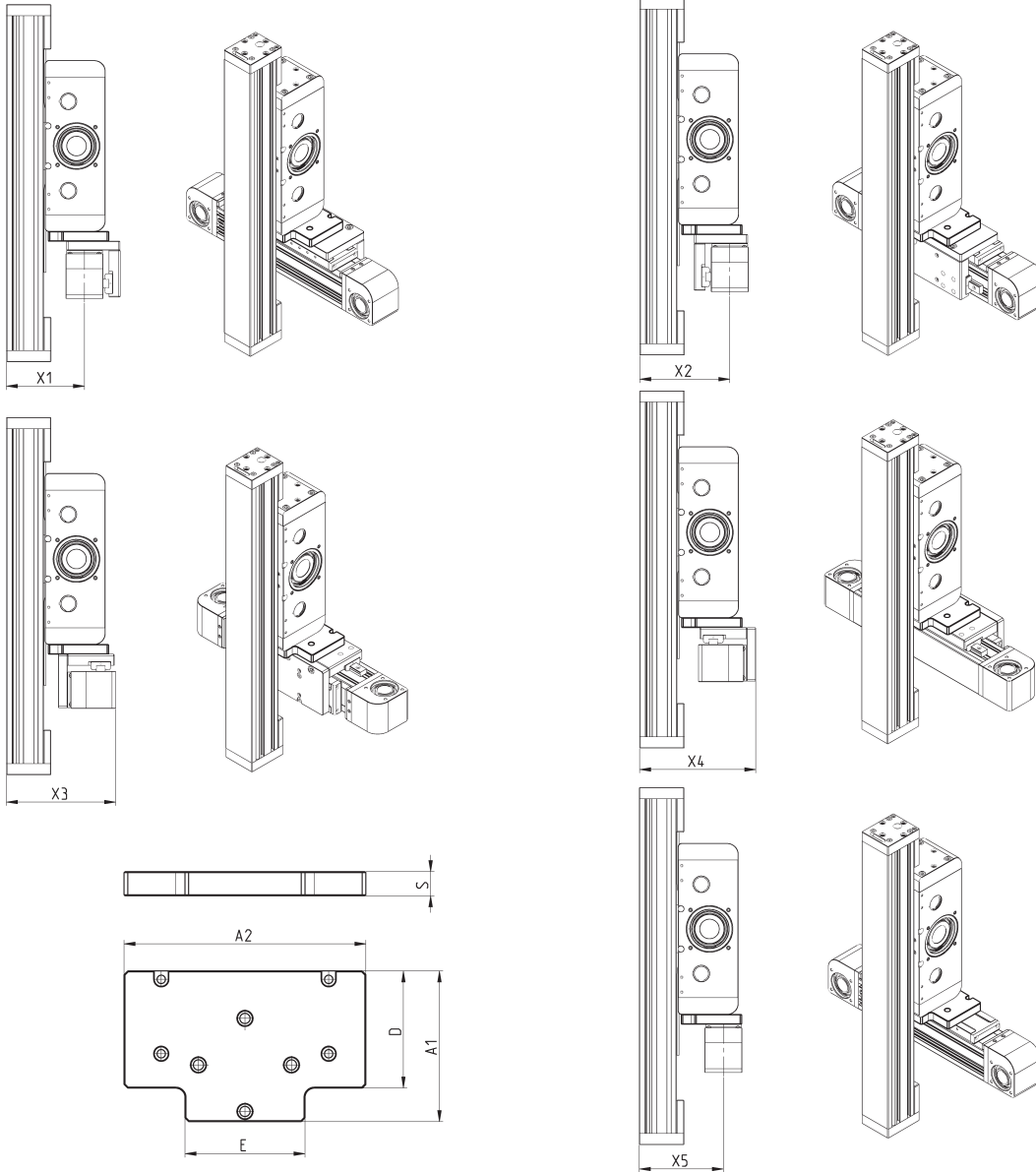

Mod.	Size	X1	X2	X3	X4	X5	A1	A2	E	D	S	Weight (g)
YZ-50-5V50	50	105	121	147	156	-	81	130	64.5	63	13	335
YZ-65-5V50	65	112.5	136.5	162	179	124.5	99.5	140	64.5	76.5	13	445
YZ-65-5V65	65	130	154	179.5	196.5	-	101.5	140	84.5	76.5	13	460
YZ-80-5V50	80	120.5	146.5	185.5	196.5	133.5	118	190	64.5	78	13	635
YZ-80-5V65	80	157.5	163.5	202.5	213.5	150.5	118	190	84.5	78	15	770
YZ-80-5V80	80	141	183.5	222.5	233.5	-	120	190	99.5	78	15	825

Products designed for industrial applications.
General terms and conditions for sale are available on www.camozzi.com.