

OX1 fittings and accessories for applications of medical gases

New

Tube external diameters: 4, 6 and 8 mm
Fittings threads: metric (M5), BSP (G1/8, G1/4), BSPT (R1/8, R1/4)

OX1 FITTINGS AND ACCESSORIES FOR APPLICATIONS OF MEDICAL GASES



OX1 fittings are designed for the Life Science market, particularly for medical and analytical applications. Equipment manufacturers of Ventilators, Anaesthesia devices, Oxygen Concentrators, Mass Spectrometry or Bio Medical analysers have qualified the Series OX1 fittings for many years.

OX1 Products Cleanliness level:
Non volatile residue equal to or less than 550 mg/m²
Level OX1 : ultrasonic cleaning of components, inspection with UV black light, lubrication with a specific grease suitable to be used with oxygen. Assembly, testing and packaging inside a clean room with ISO7 classification according to ISO 14644-1

- » Ultrasonic cleaning
- » Assembly and packing in ISO7 classified clean room
- » Oxygen suitable grease
- » Approved Collet technology
- » Long life service
- » Use with PA, PU, PE or Fluoropolymer Tubings

Serie 6000 OX1 push in fittings:
Series 6000 OX1 super-rapid fittings have been designed with a special collet which provides an homogeneous tight on the whole surface of plastic tubes, thus ensuring high reliability and a long service life, also after connections and disconnections of the tube are repeated several times.

Serie VNR OX1 unidirectional valves:
They are available with Integrated Push-in Fittings. Thanks to their construction they operate at low pressure.

Serie 2000 OX1 brass pipe fittings:
The wide range of Camozzi pipe fittings, which includes straight, L and Tee, male or female couplings, guarantees the necessary support during the design of medical and analytical systems.

GENERAL CHARACTERISTICS

Series 6000	
Diameters	∅ 4, 6 and 8mm
Threads	GAS cylindrical ISO 228 (BSP); M5
Temperature	-20 °C ÷ 80 °C (see the technical data of tubing used)
Tube to connect	Polyamide (PA) 6 - 11 - 12, Polyurethane (PU), Polyethylene (PE), hytel Fluoropolymer. O-ring with NBR with Oxygen suitable grease
Fluid	Oxygen, Medical Gases, Compressed Air or Other low pressure fluids
Materials	Standard models: body and collet in nickel-plated brass, O-ring with NBR with Oxygen suitable grease.
Working pressure	Standard models: min -0,9 bar - max 16 bar (see tubing)

Series VNR	
Valve group	automatic valves
Construction	poppet-type
Materials	brass body stainless steel spring FKM seals
Mounting	in any position
Dimensions tube version	∅4; ∅6; ∅8
Operating temperature	0 °C ÷ 80 °C
Fluid	Oxygen, Medical Gases, Compressed Air or Other low pressure fluids

Series 2000	
Threads	GAS conical ISO 7 (BSPT) GAS cylindrical ISO 228 (BSP)
Temperature	-40 °C ÷ 120 °C
Fluid	compressed air or other low pressure fluids Oxygen, Medical Gases, Compressed Air or Other low pressure fluids
Materials	nickel-plated brass
Working pressure	80 bar

OX1 FITTINGS AND ACCESSORIES FOR APPLICATIONS OF MEDICAL GASES

Fittings Mod. 6512-OX1

New

Metric-BSP Male Connector

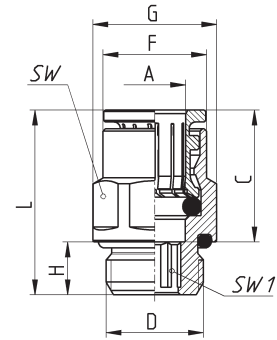

DIMENSIONS										
Mod.	A	D	C	F	G	H	L	SW	SW1	Weight (g)
6512 4-M5-OX1	4	M5	14.0	7.8	8.8	4	20	8	2	4
6512 4-1/8-OX1	4	G1/8	14.0	8.8	13.5	6	19	12	2.5	10
6512 6-M5-OX1	6	M5	16.0	11.7	13.2	4	22	12	2	8
6512 6-1/8-OX1	6	G1/8	16.0	11.7	13.5	6	21	12	4	10
6512 6-1/4-OX1	6	G1/4	16.0	11.7	16.4	7	22	15	4	13
6512 8-1/8-OX1	8	G1/8	17.5	13.7	15.2	6	26	14	5	15
6512 8-1/4-OX1	8	G1/4	17.5	13.7	16.4	7	24.5	15	6	17

Fittings Mod. 6700-OX1

New

Cartridge

S* = for both metallic and synthetic seat

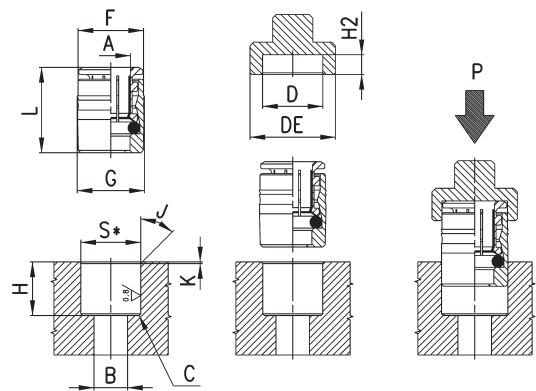

Mod.	A	B	C	D	DE	F	G	H	H2	J	K	L	P min	P max	S (+0,01/-0,04)	Weight (g)
6700 4-OX1	4	3.5	0.5x45°	8.8	14	8.6	9	11	3.3	15°	0.5	14.5	200	360	8.75	4
6700 6-OX1	6	4	0.5x45°	12	17	11.8	12.2	12	3.8	15°	0.5	16.5	160	570	11.95	8

New

Fittings Mod. 6463-OX1

Metric-BSP Female Connector

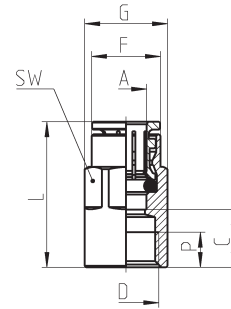

DIMENSIONS									
Mod.	A	D	C	F	G	L	P (min)	SW	Weight (g)
6463 4-1/8-OX1	4	G1/8	10	9	13	24	6	12	14
6463 6-1/8-OX1	6	G1/8	10	11.7	13	26	6	12	14
6463 6-1/4-OX1	6	G1/4	11.5	11.9	16.5	27.5	7	15	23

New

Fittings Mod. 6522-OX1

Metric-BSP Swivel Male Elbow

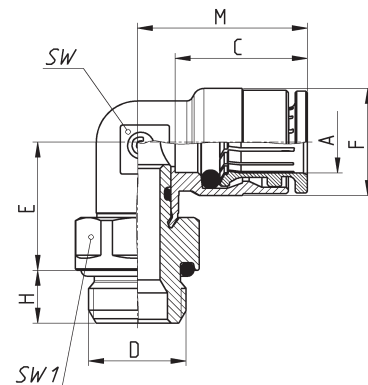

DIMENSIONS										
Mod.	A	D	C	E	F	H	M	SW	SW1	Weight (g)
6522 4-M5-OX1	4	M5	14.0	12.5	9	4	17.5	8	8	12
6522 4-1/8-OX1	4	G1/8	14.0	14.5	9	6	17.5	8	12	15
6522 6-M5-OX1	6	M5	16.0	13	12.7	4	20	9	10	14
6522 6-1/8-OX1	6	G1/8	16.0	15	12.7	6	20	9	12	19
6522 6-1/4-OX1	6	G1/4	16.0	16	12.7	7	20	9	15	27
6522 8-1/8-OX1	8	G1/8	17.5	16	14.2	6	22.5	11	12	22
6522 8-1/4-OX1	8	G1/4	17.5	17	14.2	7	22.5	11	15	28

Fittings Mod. 6590-OX1

New

Bulkhead Connector

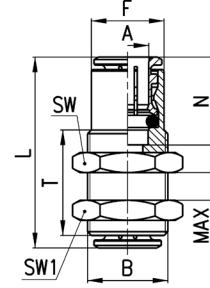

DIMENSIONS										
Mod.	A	B	F	L	N	MAX	SW	SW1	T	Weight (g)
6590 4-OX1	4	M10x1	8.8	29	14	10.5	14	14	20	16
6590 6-OX1	6	M14x1	12.5	33	16	10.5	17	17	20	28

Fittings Mod. 6580-OX1

New

Union Connector

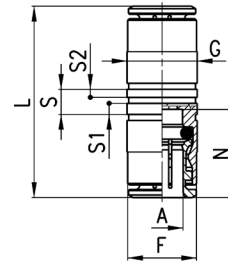

DIMENSIONS										
Mod.	A	F	G	L	N	S	S1	S2	Weight (g)	
6580 4-OX1	4	8.4	9	29	14	5	2.2	1.6	11	
6580 6-OX1	6	11.7	12	34	16	5	2.2	1.6	16	
6580 8-OX1	8	13.7	14	37	17.5	5	2.2	1.6	23	

Fittings Mod. 6550-OX1

New

Elbow connector

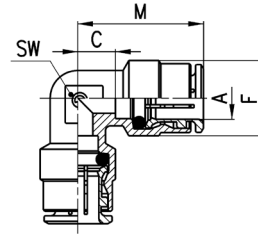

DIMENSIONS						
Mod.	A	C	F	M	SW	Weight (g)
6550 4-OX1	4	3.5	9	17.5	8	8
6550 6-OX1	6	4	12.7	20	9	17

OX1 FITTINGS AND ACCESSORIES FOR APPLICATIONS OF MEDICAL GASES

Fittings Mod. 6540-OX1

New

Tee Connector

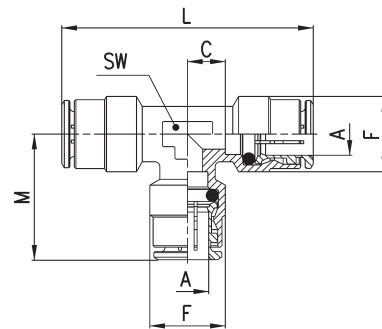

DIMENSIONS							
Mod.	A	C	F	L	M	SW	Weight (g)
6540 4-OX1	4	3.5	9	35	17.5	8	14
6540 6-OX1	6	4	12.7	40	20	9	24

Fittings Mod. 6560-OX1

New



Y Union

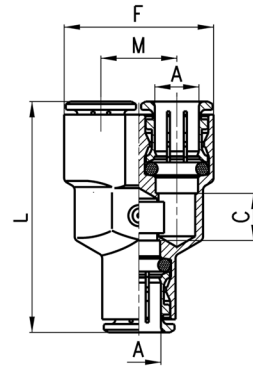

DIMENSIONS						
Mod.	A	C	F	L	M	Weight (g)
6560 4-OX1	4	5	18	33	9	19
6560 6-OX1	6	7	24.5	39	12.5	30

Fittings Mod. 6750-OX1

New



Female Plug

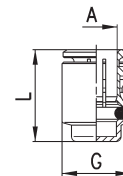

DIMENSIONS				
Mod.	A	G	L	Weight (g)
6750 4-OX1	4	8.8	15	4
6750 6-OX1	6	11.8	17	7

OX1 FITTINGS AND ACCESSORIES FOR APPLICATIONS OF MEDICAL GASES

Fittings Mod. 6800-OX1

New



Reducer Junction

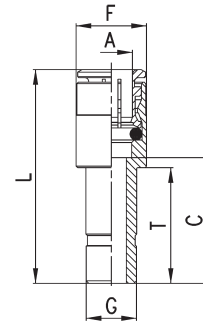

DIMENSIONS							
Mod.	A	G	C	F	L	T	Weight (g)
6800 4-6-OX1	4	6	15.5	9	29.5	18	9
6800 4-8-OX1	4	8	18	9	32	20.5	10
6800 6-8-OX1	6	8	18	12.7	34	20.5	12

Fittings Mod. 6555-OX1

New



Junction Elbow

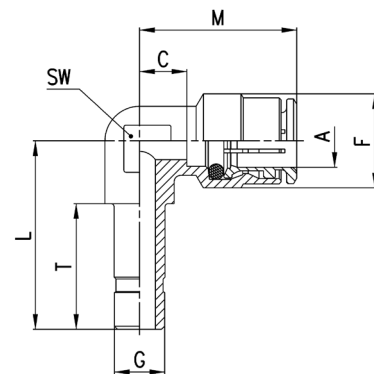

DIMENSIONS										
Mod.	A	G	C	L	F	T	M	SW	Weight (g)	
6555 6-6-OX1	6	6	4	24.5	12.7	18	20	9	14	

Accessory Mod. 6900-OX1

New



Plastic Male Plug

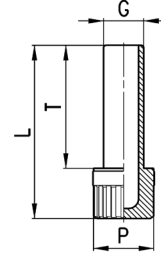

DIMENSIONS					
Mod.	G	L	P	T	Weight (g)
6900 4-OX1	4	29	8	20	1
6900 6-OX1	6	31.5	8	22.5	1

Series VNR unidirectional valves

New

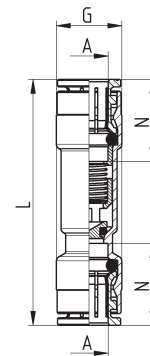

Mod.	A	G	L	N	Flow 6 bar $\Delta P1$ (NL/min)	Min. operating pressure (bar)	Max operating pressure (bar)	Weight (g)
6580 4-VNR-OX1	4	9	40	14	85	0,2	10	13
6580 6-VNR-OX1	6	12	48	16	450	0,2	10	20
6580 8-VNR-OX1	8	14	52.5	17.5	900	0,2	10	30



New

Fittings Mod. 2500-OX1

BSPT Nipple

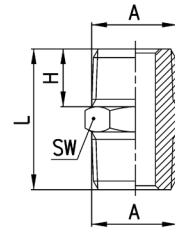

DIMENSIONS					
Mod.	A	H	L	SW	Weight (g)
2500 1/8-OX1	R1/8	7,5	19,5	12	9
2500 1/4-OX1	R1/4	11	27	14	16

New

Fittings Mod. 2501-OX1

Metric-BSP Nipple

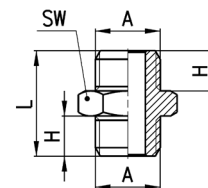

DIMENSIONS					
Mod.	A	H	L	SW	Weight (g)
2501 1/8-OX1	G1/8	6	16,5	13	9
2501 1/4-OX1	G1/4	8	21	17	15

Fittings Mod. 2510-OX1

New

BSPT Reducing Nipple

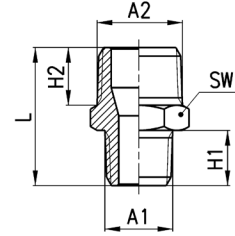

DIMENSIONS							
Mod.	A1	A2	H2	H1	L	SW	Weight (g)
2510 1/8-1/4-OX1	R1/8	R1/4	11	7,5	23,5	14	14

Fittings Mod. 2531-OX1

New

BSP Reducing

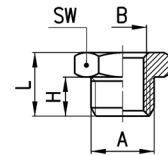

DIMENSIONS							
Mod.	A	B	H	L	SW	Weight (g)	
2531 1/8-M5-OX1	G1/8	M5	6	10,5	13	8	*
2531 1/4-1/8-OX1	G1/4	G1/8	8	13	17	11	*

* = with through-out thread

Fittings Mod. 2543-OX1

New

Sleeve

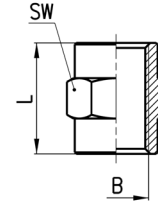

DIMENSIONS				
Mod.	B	L	SW	Weight (g)
2543 M5-OX1	M5	11	8	3
2543 1/8-OX1	G1/8	15	13	8
2543 1/4-OX1	G1/4	22	17	19

Fittings Mod. 2611-OX1

New

BSP Male Plug

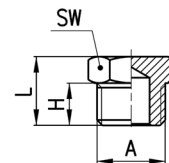

DIMENSIONS					
Mod.	A	H	L	SW	Weight (g)
2611 M5-OX1	M5	4	7,5	8	2
2611 1/8-OX1	G1/8	6	10,5	13	7
2611 1/4-OX1	G1/4	8	13	17	13

Fittings Mod. 2013-OX1

New

BSPT Female Elbow

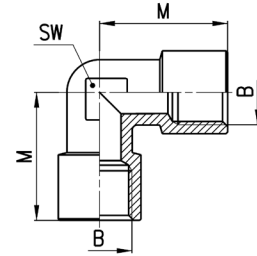

DIMENSIONS				
Mod.	B	M	SW	Weight (g)
2013 1/8-OX1	G1/8	19	11	16
2013 1/4-OX1	G1/4	23	14	28

OX1 FITTINGS AND ACCESSORIES FOR APPLICATIONS OF MEDICAL GASES

Fittings Mod. 2021-OX1 and 2020-OX1

New

Mod. 2021-OX1: Metric Male Female Elbow
Mod. 2020-OX1: BSPT Male Female Elbow

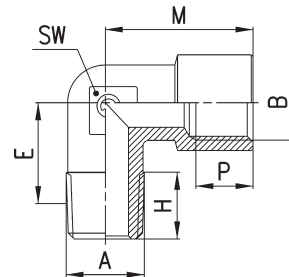

DIMENSIONS								
Mod.	A	B	E	H	M	P (min)	SW	Weight (g)
2020 1/8-1/8-OX1	R1/8	G1/8	11,5	8,5	19	6	11	17
2020 1/4-1/4-OX1	R1/4	G1/4	15	11	23	7	13	27

Fittings Mod. 2003-OX1

New

Female Tee

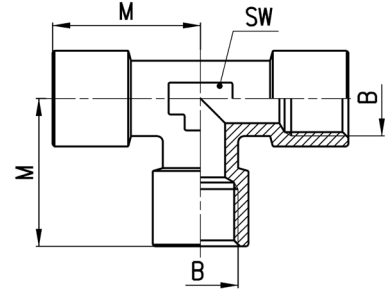

DIMENSIONS				
Mod.	B	M	SW	Weight (g)
2003 1/8-OX1	G1/8	19	12	23
2003 1/4-OX1	G1/4	23	13	39

OX1 FITTINGS AND ACCESSORIES FOR APPLICATIONS OF MEDICAL GASES

Fittings Mod. 2043-OX1

New

Female Y

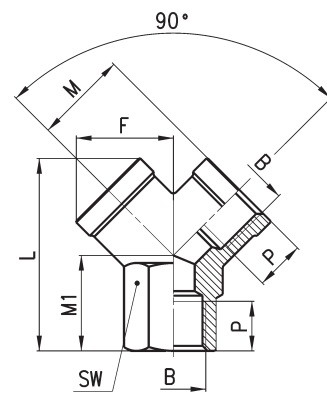

DIMENSIONS								
Mod.	B	F	L	M	M1	P	SW	Weight (g)
2043 1/8-OX1	G1/8	14,5	26,5	14	12	8	13	18
2043 1/4-OX1	G1/4	18	32	17,5	14	11	17	32