

Series ER200 digital electro-pneumatic regulators

Ports G1/4 and G3/8



- » Compact design
- » Digital display
- » Analog and digital input
- » Programmable
- » Zero/span adjustment function
- » Error display function, pressure display
- » Preset memory function 8-set points (3 bits).

GENERAL DATA ER2XX-5XXX

Model	ER204-5 0/1/2 X ER238-5 0/1/2 X Analog type	ER204-5P X ER238-5P X Parallel type
Fluid	filtered compressed air, unlubricated, according to ISO 8573-1 class 3.4.3, inert gas	filtered compressed air, unlubricated, according to ISO 8573-1 class 3.4.3, inert gas
Max. working pressure	7 bar	7 bar
Min. working pressure	Control pressure + max. control pressure + 1 bar	Control pressure + max. control pressure + 1 bar
Pressure control range	0,3 ÷ 5 bar	0,3 ÷ 5 bar
Class protection	IP40	IP40
Power supply voltage	DC24V ± 10% (stabilized power supply with a ripple rate of 1% or less)	DC24V ± 10% (stabilized power supply with a ripple rate of 1% or less)
Consumption current	0.15 A (rush current 0.6 A or less)	0.15 A (rush current 0.6 A or less)
Input signal(Input Impedance)	0 to 10 VDC (6.7k Ω) 0 to 5 VDC (10k Ω) 4 to 20 mA DC (250 Ω)	10 bit
Preset input	8 points	N/A
Output signal Note 1	Analog output 1-5 VDC (load to be connected impedance 500 kΩ or more) Switch output NPN or PNP, open collector output, 30 V, 50 mA, voltage drop 2.4 V, compatible for usage in PLC and Relay.	Analog output 1-5 VDC (load to be connected impedance 500 kΩ or more) Switch output NPN or PNP, open collector output, 30 V, 50 mA, voltage drop 2.4 V, compatible for usage in PLC and Relay.
Error output signal	NPN or PNP, open collector, 30 V, 50 mA, voltage drop 2.4 V, compatible for usage in PLC and Relay.	NPN or PNP, open collector, 30 V, 50 mA, voltage drop 2.4 V, compatible for usage in PLC and Relay.
Direct memory setting	0,05 ÷ 5 bar minimum input width 0,01 bar	0,05 ÷ 5 bar minimum input width 0,01 bar
Hysteresis Note 2	0.5% F.S. or less	0.5% F.S. or less
Linearity Note 2	±0.3% F.S. or less	±0.3% F.S. or less
Resolution Note 2	0.2% F.S. or less	0.2% F.S. or less
Repeatability Note 2	0.3% F.S. or less	0.3% F.S. or less
Temperature characteristics: zero point fluctuation	0.15% F.S./°C or less	0.15% F.S./°C or less
Temperature characteristics: span point fluctuation	0.07% F.S./°C or less	0.07% F.S./°C or less
Max. flow rate(ANR) Note 3	1500 l/min	1500 l/min
Step response time: no load	0.2 sec. or less	0.2 sec. or less
Step response time: With load 1000 cm³	0.8 sec. or less	0.8 sec. or less
Mechanical vibration proof	98 m/s ² or less	98 m/s ² or less
Ambient temperature	5°C ÷ 50 °C	5°C ÷ 50 °C
Fluid temperature	5°C ÷ 50 °C	5°C ÷ 50 °C
Connecting port size IN/OUT	G1/4 - G3/8	G1/4 - G3/8
Connecting port size EXHAUST	G3/8	G3/8
Mounting	Free	Free
Weight	450g	450g
Note 1:	Select either analog or switch output.	
Note 2:	This characteristic is guaranteed within a regulation range between 10 and 90% of the full scale, with a power voltage of 24V±10%, a supply pressure of 1 bar higher compared with the set pressure (ex. regulation of 3 bar, supply pressure of 3+1 = 4 bar) and a volume connected to the outlet without any loss. In applications with great air consumption, such as the blowing, the indicated tolerance may change.	
Note 3:	The above apply when working pressure and control pressure are maximum.	
Note 4:	The above apply when working pressure is maximum and the step is as follows: 50% F.S. -> 100% F.S. 50% F.S. -> 60% F.S. 50% F.S. -> 40% F.S.	

GENERAL DATA ER2XX-9XXX

Model	ER204-9 0/1/2 X ER238-9 0/1/2 X Analog type	ER238-9P X ER238-9P X Parallel type
Fluid	Cleaned air	Cleaned air
Max. working pressure	10 bar	10 bar
Min. working pressure	Control pressure + max. control pressure + 1 bar	Control pressure + max. control pressure + 1 bar
Pressure control range	0,5 - 9 bar	0,5 - 9 bar
Class protection	IP40	IP40
Power supply voltage	DC24V ± 10% (stabilized power supply with a ripple rate of 1% or less)	DC24V ± 10% (stabilized power supply with a ripple rate of 1% or less)
Consumption current	0.15 A (rush current 0.6 A or less)	0.15 A (rush current 0.6 A or less)
Input signal (Input impedance)	0 to 10 VDC (6.7kΩ) 0 to 5 VDC (10kΩ) 4 to 20 mA DC (250Ω)	10 bit
Preset input	8 points	N/A
Output signal	Analog output 1-5 VDC (load to be connected impedance 500 kΩ) Switch output NPN or PNP, open collector, 30 V, 50 mA, voltage drop 2.4 V, compatible for usage in PLC and Relay	Analog output 1-5 VDC (load to be connected impedance 500 kΩ) Switch output NPN or PNP, open collector, 30 V, 50 mA, voltage drop 2.4 V, compatible for usage in PLC and Relay
Error output signal	NPN or PNP, open collector, 30 V, 50 mA, voltage drop 2.4 V, compatible for usage in PLC and Relay	NPN or PNP, open collector, 30 V, 50 mA, voltage drop 2.4 V, compatible for usage in PLC and Relay
Direct memory setting	0,05 - 9 bar - min. input 0,01 bar max. error 0,02 bar	0,05 - 9 bar - min. input 0,01 bar max. error 0,02 bar
Hysteresis Note 2	0.5% F.S. or less	0.5% F.S. or less
Linearity Note 2	±0.3% F.S. or less	±0.3% F.S. or less
Resolution Note 2	0.2% F.S. or less	0.2% F.S. or less
Repeatability Note 2	0.3% F.S. or less	0.3% F.S. or less
Temperature characteristics: Zero point fluctuation	0.15% F.S./°C or less	0.15% F.S./°C or less
Temperature characteristics: Span point fluctuation	0.07% F.S./°C or less	0.07% F.S./°C or less
Max. flow rate(ANR) Note 3	1500 l/min	1500 l/min
Step response time No load	0.2 sec. or less	0.2 sec. or less
Step response time Load 1000 cm³	0.8 sec. or less	0.8 sec. or less
Mechanical vibration proof	98 m/s ²	98 m/s ²
Ambient temperature	5 to 50 °C	5 to 50 °C
Fluid temperature	5 to 50 °C	5 to 50 °C
Connecting port size IN/OUT	G1/4 - G3/8	G1/4 - G3/8
Connecting port size EXHAUST	G3/8	G3/8
Mounting	Free	Free
Weight	450g	450g
Note 1:	Select either analog or switch output	
Note 2:	This characteristic is guaranteed within a regulation range between 10 and 90% of the full scale, with a power voltage of 24V±10%, a supply pressure of 1 bar higher compared with the set pressure (ex. regulation of 3 bar, supply pressure of 3+1 = 4 bar) and a volume connected to the outlet without any loss. In applications with great air consumption, such as the blowing, the indicated tolerance may change.	
Note 3:	The above apply when working pressure and control pressure are maximum.	
Note 4:	The above apply when working pressure is maximum and the step is as follows: 50% F.S. -> 100% F.S. 50% F.S. -> 60% F.S. 50% F.S. -> 40% F.S.	

STANDARD CODES

Models				
ER238-50AP	ER238-52AP	ER238-5PSP	ER238-90SP	ER238-92SP
ER238-50SP	ER238-52SP	ER238-90AP	ER238-92AP	ER238-9PSP

CODING EXAMPLE

ER	2	04	-	5	0	AN
-----------	----------	-----------	----------	----------	----------	-----------

ER	SERIES
2	SIZE: 2 = size 2
04	PORT: 04 = G1/4 38 = G3/8
5	WORKING PRESSURE: 5 = 0 ÷ 5 bar 9 = 0.5 ÷ 9 bar
0	INPUT: 0 = 0 - 10 V DC 1 = 0 - 5 V DC 2 = 4 - 20 mA P = Parallel 10 bit
AN	OUTPUT: AN = 1 - 5 V analog error (NPN) AP = 1 - 5 V analog, error (PNP) SN = switch(NPN), error(NPN) SP = switch (PNP), error (PNP)

SERIES ER200 DIGITAL ELECTRO-PNEUMATIC REGULATORS

DIAGRAMS

SERIES ER200 DIGITAL ELECTRO-PNEUMATIC REGULATORS

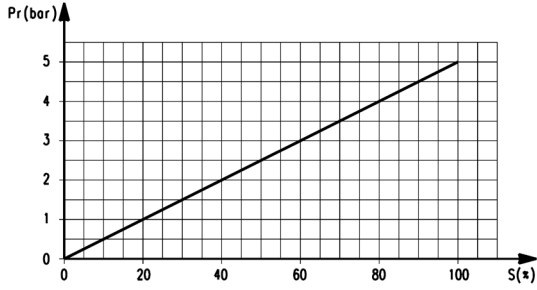

ER2xx-5xxx
Input/Output characteristics

Pr = outlet pressure (bar)
S = input signal (%)

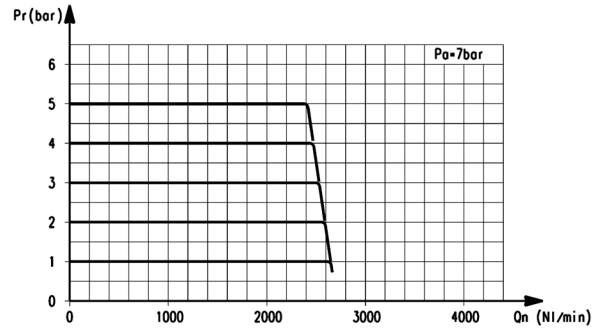

ER204-5xxx
Flow characteristics

Pr = outlet pressure (bar)
Qn = flow (l/min)
Pa = working pressure (bar)

DIAGRAMS

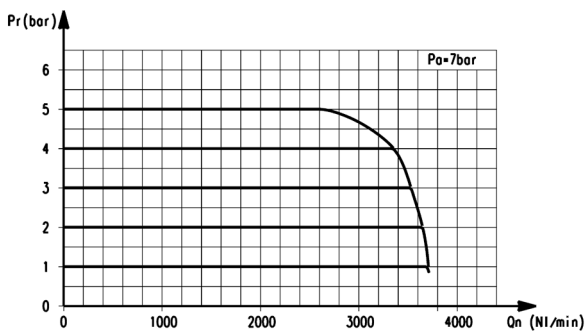

ER238-5xxx
Flow characteristics

Pr = outlet pressure (bar)
Qn = flow (l/min)
Pa = working pressure (bar)

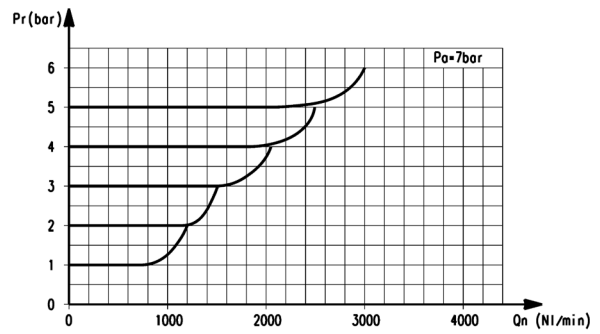

ER2xx-5xxx
Exhaust characteristics

Pr = outlet pressure (bar)
Qn = flow (l/min)
Pa = working pressure (bar)

DIAGRAMS

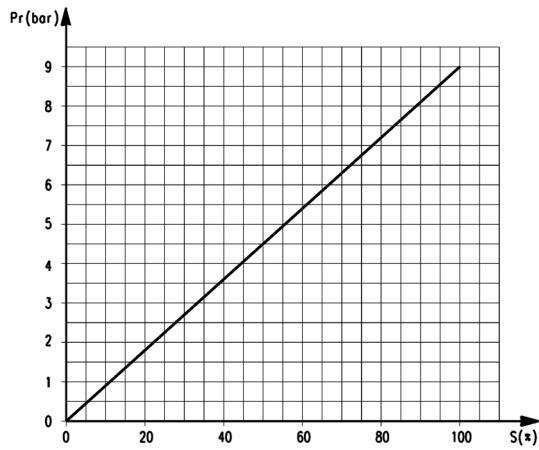

ER2xx-9xxx
Input/Output characteristics

Pr = output pressure (bar)
S = inlet signal (%)
Pa = working pressure (bar)

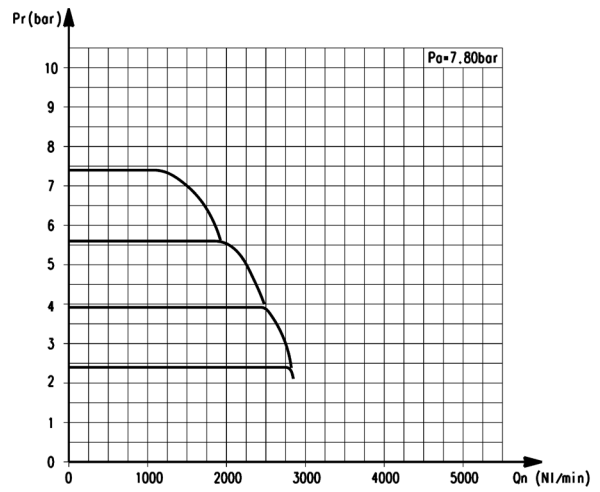

ER204-9xxx
Flow characteristics
Pr = output pressure (bar)
Qn = flow (l/min)
Pa = working pressure (bar)

DIAGRAMS

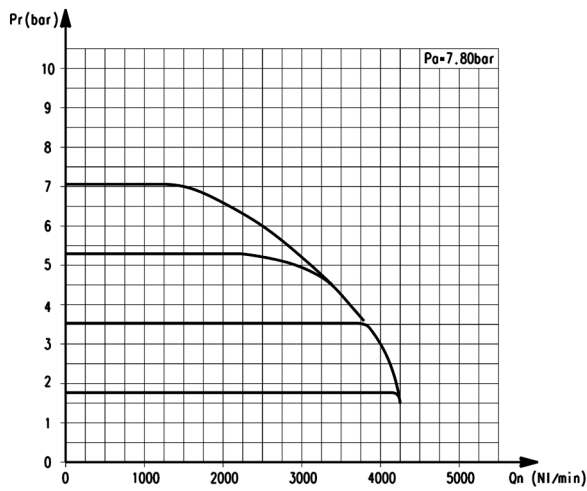

ER238-9xxx
Flow characteristics

Pr = output pressure (bar)
Qn = flow (l/min)
Pa = working pressure (bar)

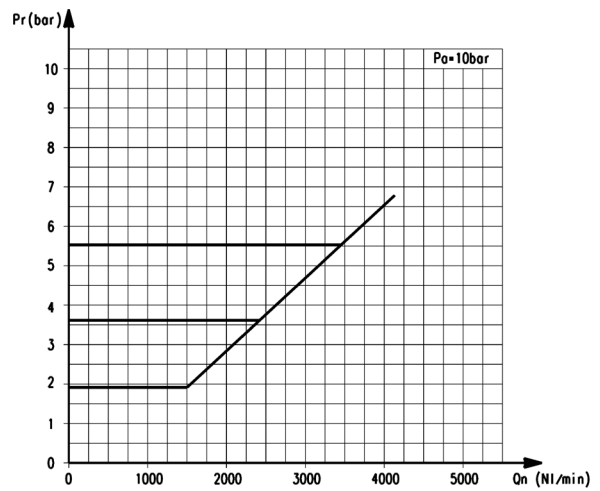

ER2xx-9xxx
Exhaust characteristics

Pr = output pressure (bar)
Qn = flow (l/min)
Pa = working pressure (bar)

Proportional regulators Series ER200

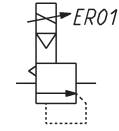

SERIES ER200 DIGITAL ELECTRO-PNEUMATIC REGULATORS

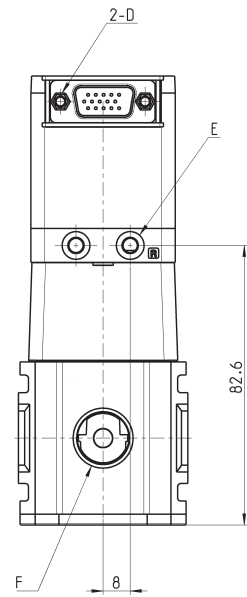
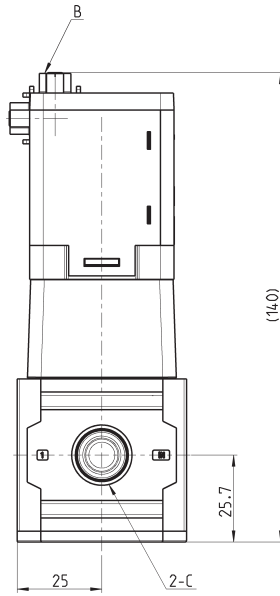
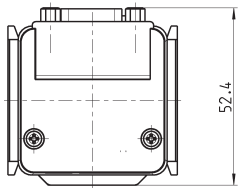
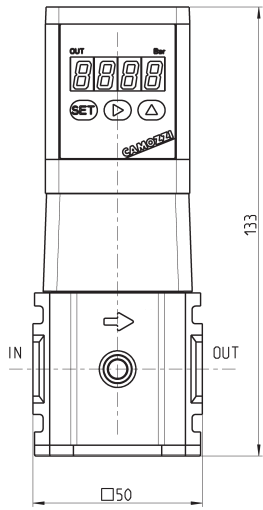
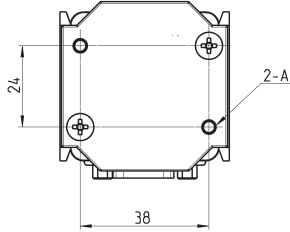

DIMENSIONS							
Mod.	A	B	C	D	E	F	
ER204	M4 depth 12	D sub-connector 15 pins/plugs	G1/4	4-40 UNC	Ø4.2 Port R (pilot air exhaust port)	G3/8 EXH port	
ER238	M4 depth 12	D sub-connector 15 pins/plugs	G3/8	4-40 UNC	Ø4.2 Port R (pilot air exhaust port)	G3/8 EXH port	

Bracket ER2-B1

Floor installation type mounting

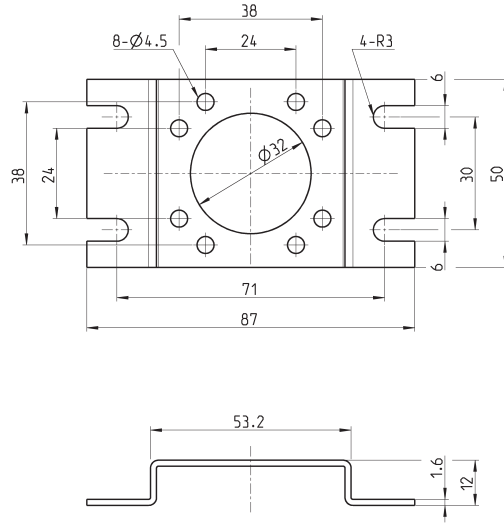

Mod.
ER2-B1

Bracket ER2-B2

Wall installation type mounting

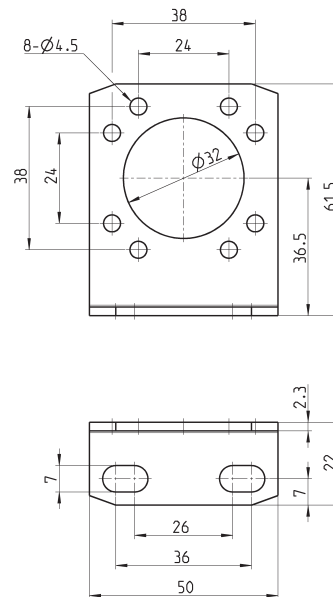

Mod.
ER2-B2

Cable and connector for regulator with analog Input



To check the correspondence between pin and cables' colour, please refer to the instruction sheet included in the packaging or to the user manual.

- 1 = shield wire*
 - 2 = 9-AWG26
- * Connect the shield wire to the power's minus (0 V) side.

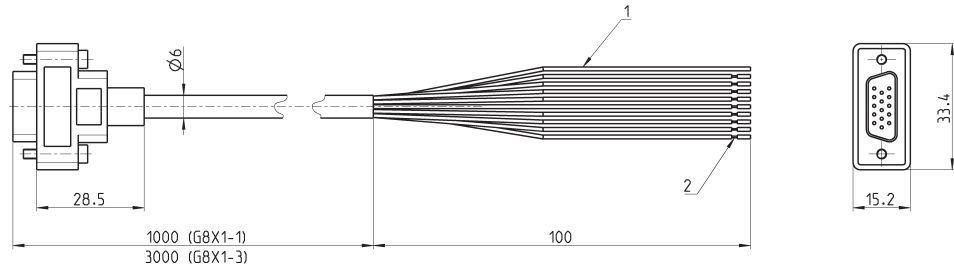

Mod.
G8X1-1
G8X1-3

Cable and connector for regulator with parallel Input



To check the correspondence between pin and cables' colour, please refer to the instruction sheet included in the packaging or to the user manual.

- 1 = shield wire*
 - 2 = 9-AWG26
- * Connect the shield wire to the power's minus (0 V) side.

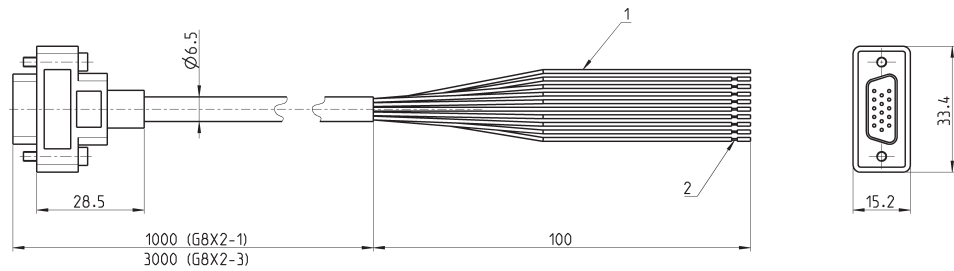

Mod.
G8X2-1
G8X2-3